



Product Features:

- Energy efficient SMD LED downlight with Brushed Nickel finishes
- Aluminium profiles provides advanced heat dissipation outcomes
- Fire-rated PC diffuser provides even light distribution
- IP54 weatherproof design, suitable for damp environment
- Cut out: Ø 85-95mm
- 0.6m Flex and 2 pin plug standard
- 3 year replacement warranty



Application:

- Commercial and residential applications: offices, homes, hospitals and hotels



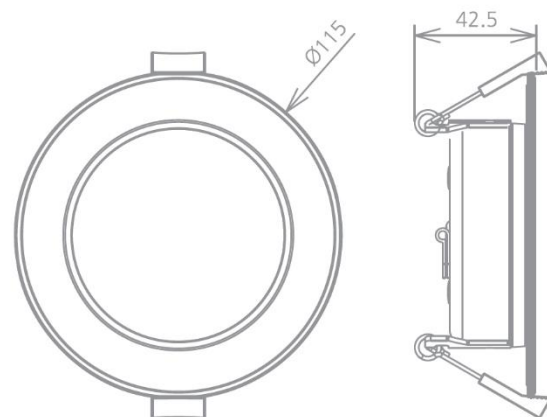



NICKEL BRUSHED SMD DOWNLIGHT



Quick Spec

Luminous Efficacy: 75 lm/w
Color temperature: 3000k/4000k/5000k
Average rated LED life: 40,000hrs @ L70
Ambient temperature: -35°C to 45°C
Beam Angle: 90°

 Cut out: 85-95mm

 90°	 IP 54	 PF ≥0.9	 CRI ≥80		 40000
---	--	---	---	---	---

Model	Watts	Supply Voltage	Lumen Output	Size (mm)	Weight	IP Rating
SL-DL61-10W	10W	AC200-240V,50Hz	710-780lm	Ø115*42.5	0.26kgs	IP54